

ENDURA® DELTA 330

pages 2-5



Endura Delta 330 T4



Endura Delta 330 T2/B2

ENDURA® DELTA 380

pages 6-9



Endura Delta 380 T4



Endura Delta 380 T2/B2

ENDURA® DELTA 450

pages 10-13



Endura Delta 450 T4



Endura Delta 450 T2/B2

OVERVIEW ENDURA® DELTA 330-380-450

pages 14-15

AREA OF APPLICATION

- Can be used in medium sized houses [2-3 bedrooms] up to 330 m³/h at 150 Pa
- Mechanically supplied fresh air
- Mechanically drainage of used air
- Demand-driven ventilation thanks to integrated air quality sensors
- High-efficiency heat exchanger for reduced heat losses



Endura Delta 330 T4

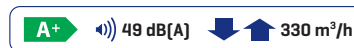

Endura Delta 330 T2/B2

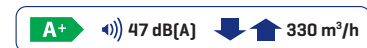

PRODUCT CHARACTERISTICS

EPB product data

- Max. capacity: 330 m³/h at 150 Pa
- Integrated plastic counter flow heat exchanger
- Maximum power consumption: 2 x 85 W

Ventilation system

- Ventilators
 - 2 EC motors
 - Supply voltage: 1 x 230V / 50Hz
 - Ventilators with forward-curved blades
 - Constant flow control: airflow remains constant
- Dimensions: H 862 x W 745 x D 520 mm
- Weight: 41 kg
- Available with 4 upper connections [T4] or 2 upper and 2 lower connections [T2/B2]
- Standard left-hand model, possible to convert to right-hand model
- Automatic full bypass
 - Modular control
 - Closing of the heat exchanger during warm weather
- 150/180 mm diameter connections in expanded polypropylene
 - Direct join to the unit:
 - EPP ducts: outer diameter 180 mm, inner diameter 150 mm
 - EPP ducts: with connecting sleeve: outer diameter 210 mm, inner diameter 180 mm
 - Other ducts: 180 mm diameter can be connected directly onto the ventilation system

- Integrated condensation drain Ø32 mm
- Extremely airtight appliance
- 2 x coarse [G4] cartridge filters [PM1 [F7] optional for supply]
 - Maintenance-friendly
 - Large filter surface area
- Ethernet connection [RJ45 connector]
 - Possibility to control unit via tablet / smartphone via local network
- External input/output contacts
 - *Open input contact [digital 0-24 V]*
 - Supply and extract disabling option – e.g. emergency OFF to switch off supply flow rate
 - Supply switch-off
 - Drainage switch-off
 - Activation of fireplace function via external contact
 - *Open output contact [digital 0-24 V]*
 - Error message
 - Filter message
 - *0-10V analogue input*
 - *0-10V analogue output*

FUNCTIONS

- Operation
 - According to automatic mode [program]
 - Manual control
 - Timers
 - Via integrated air quality sensors [RH, CO₂ & VOC]
 - Via optional, external air quality sensors
- Demand-driven ventilation thanks to integrated air quality sensors
 - Relative humidity
 - VOC [volatile organic compounds]
 - CO₂
 - Ventilation levels adapted in accordance with measured air quality
- Automatic frost protection
 - Temporary imbalance and flow restriction to prevent freezing of the heat exchanger
- Extra frost protection option through installation of pre-heating element
 - Electrical pre-heating element
 - Modular power
 - Max. power: 1000 W
- Breeze function
 - Breeze function for optimum cooling in summer [summer bypass with adjustable ventilation level]
 - Automatic and manual bypass activation
 - 4-seasons automatically controlled indoor temperature
- Fireplace function
 - Activated via external pulse switch
 - Temporary imbalance on supply side [overpressure] to aid ignition process
- Holiday mode
 - Input of start and end dates during prolonged absence
 - System ventilates at maximum energy efficiency
- Filter message
 - Via smartphone
 - On external control unit [optional]
 - Timer-controlled

CONTROL

Standard

- Control via Endura[®] Delta App [iOS, Android] on smartphone and tablet

Option

- Master air quality sensor [76050332]
 - Display of air quality and ventilation intensity
 - Integrated air quality sensor
 - Display of active program
 - Timer programming possible
 - Power via motor unit [connect directly to the motor unit]
- Slave air quality sensor [76050333]
 - Always in combination with Master
 - Wireless communication with Master
 - Power voltage 230V / 50Hz
 - Integrated air quality sensor
 - Same information as on the Master available
- 4-position switch [on request]
 - Limited functionality



Endura[®] Delta app



TouchDisplay

MODELS

DESIGNATION	ARTICLE NUMBER
Endura Delta 330 T4	76050800
Endura Delta 330 T4 PH	76050801
Endura Delta 330 T2/B2	76050802
Endura Delta 330 T2/B2 PH	76050803

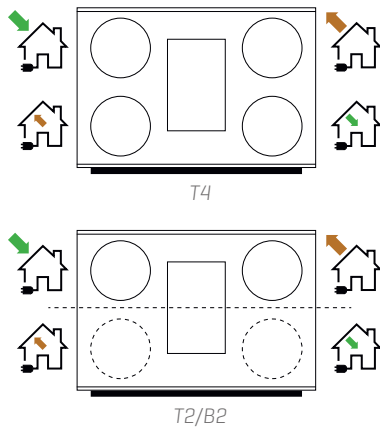
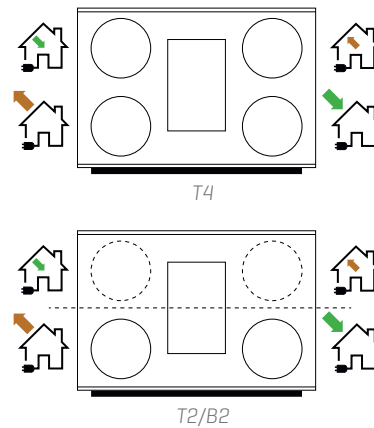
Endura Delta 330 Left [standard]

Endura Delta 330 Right [only possible after conversion]

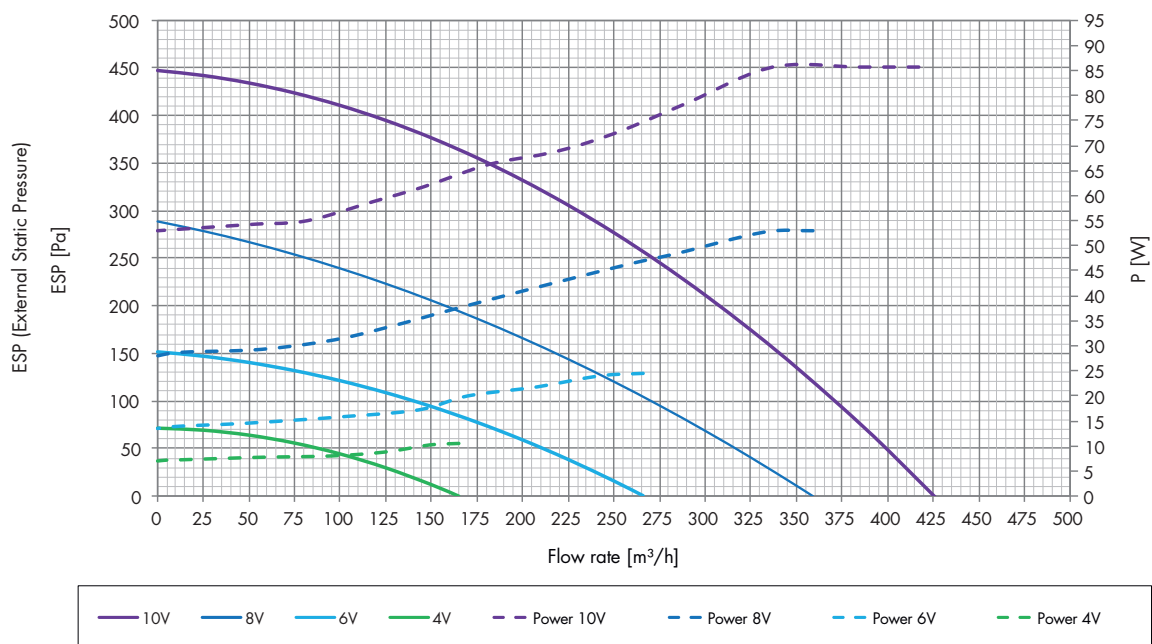
PRESSURE CURVES

 Fan curves for the Endura Delta 330
 pressure based on flow rate

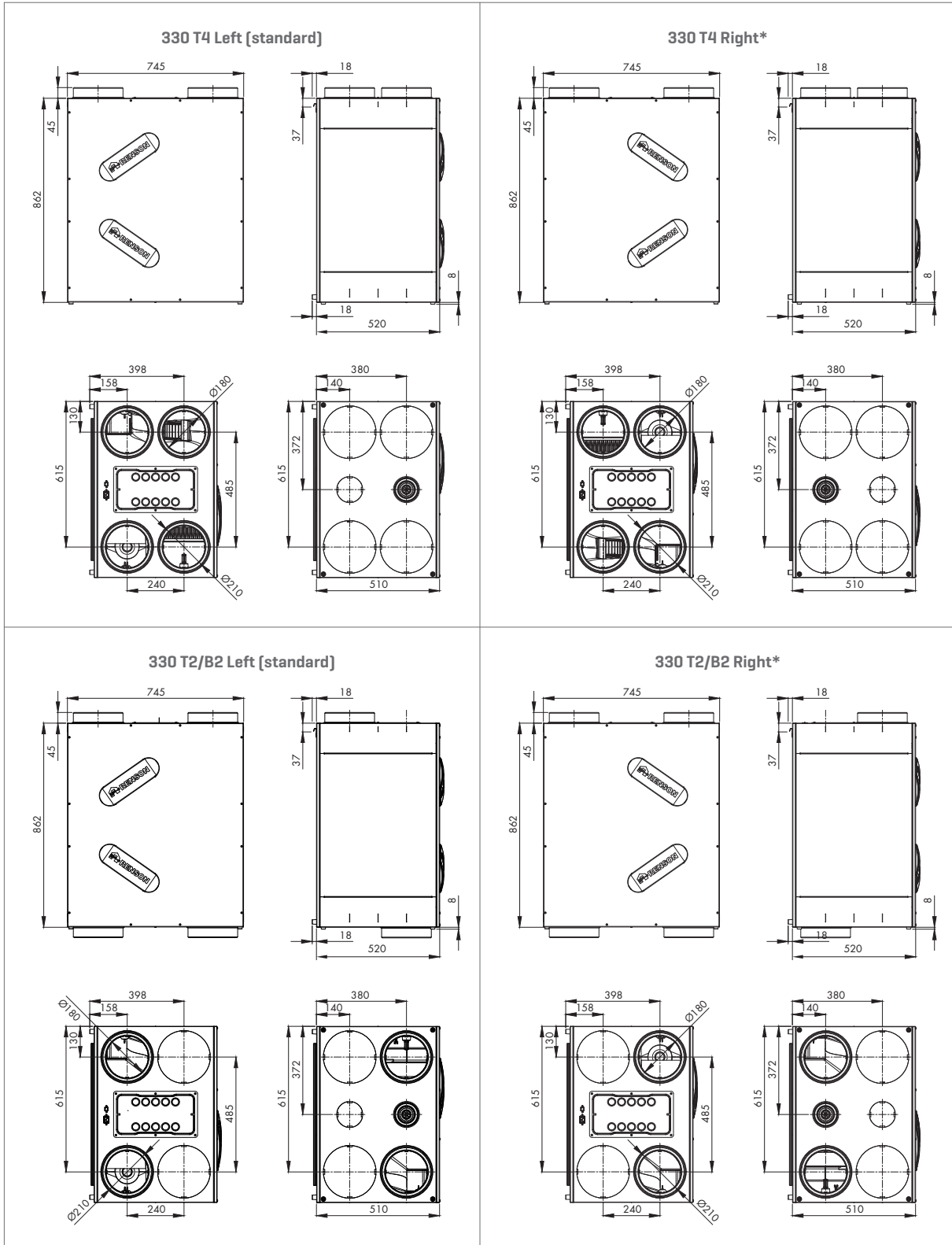
TECHNICAL DRAWINGS



* Only possible after conversion.

AREA OF APPLICATION

- Can be used in spacious houses (3-4 bedrooms) up to 380 m³/h at 150 Pa
- Mechanically supplied fresh air
- Mechanically drainage of used air
- Demand-driven ventilation thanks to integrated air quality sensors
- High-efficiency heat exchanger for reduced heat losses



Endura Delta 380 T4

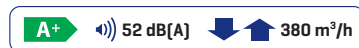

Endura Delta 380 T2/B2

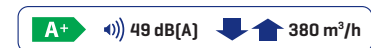

PRODUCT CHARACTERISTICS

EPB product data

- Max. capacity: 380 m³/h at 150 Pa
- Integrated plastic counter flow heat exchanger
- Maximum power consumption: 2 x 83 W

Ventilation system

- Ventilators
 - 2 EC motors
 - Supply voltage: 1 x 230V / 50Hz
 - Ventilators with backward-curved blades
 - Constant flow control: airflow remains constant
- Dimensions: H 862 x W 745 x D 520 mm
- Weight: 46 kg
- Available with 4 upper connections [T4] or 2 upper and 2 lower connections [T2/B2]
- Standard left-hand model, possible to convert to right-hand model
- Automatic full bypass
 - Modular control
 - Closing of the heat exchanger during warm weather
- 150/180 mm diameter connections in expanded polypropylene
 - Direct join to the unit:
 - EPP ducts: outer diameter 180 mm, inner diameter 150 mm
 - EPP ducts: with connecting sleeve: outer diameter 210 mm, inner diameter 180 mm
 - Other ducts: 180 mm diameter can be connected directly onto the ventilation system

- Integrated condensation drain Ø32 mm
- Extremely airtight appliance
- 2 x coarse [G4] cartridge filters [PM1 [F7] optional for supply]
 - Maintenance-friendly
 - Large filter surface area
- Integrated TouchDisplay in front panel
 - Touchscreen
 - Possibility to configure and control ventilation unit
 - Error feedback
 - Filter message
 - Visualization of current ventilation conditions
- Ethernet connection [RJ45 connector]
 - Possibility to control unit via tablet / smartphone via local network
- External input/output contacts
 - Open input contact [digital 0-24 V]
 - Supply and extract disabling option – e.g. emergency OFF to switch off supply flow rate
 - Supply switch-off
 - Drainage switch-off
 - Activation of fireplace function via external contact
 - Open output contact [digital 0-24 V]
 - Error message
 - Filter message
 - 0-10V analogue input
 - 0-10V analogue output

FUNCTIONS

- Operation
 - According to automatic mode [program]
 - Manual control
 - Timers
 - Via integrated air quality sensors [RH, CO₂ & VOC]
 - Via optional, external air quality sensors
- Demand-driven ventilation thanks to integrated air quality sensors
 - Relative humidity
 - VOC [volatile organic compounds]
 - CO₂
 - Ventilation levels adapted in accordance with measured air quality
- Automatic frost protection
 - Temporary imbalance and flow restriction to prevent freezing of the heat exchanger
- Extra frost protection option through installation of pre-heating element
 - Electrical pre-heating element
 - Modular power
 - Max. power: 1000 W
- Breeze function
 - Breeze function for optimum cooling in summer [summer bypass with adjustable ventilation level]
 - Automatic and manual bypass activation
 - 4-seasons automatically controlled indoor temperature
- Fireplace function
 - Activated via external pulse switch
 - Temporary imbalance on supply side [overpressure] to aid ignition process
- Holiday mode
 - Input of start and end dates during prolonged absence
 - System ventilates at maximum energy efficiency
- Filter message
 - Via smartphone
 - On integrated TouchDisplay
 - On external control unit [optional]
 - Timer-controlled

CONTROL

Standard

- With Endura Delta app
 - iOS, Android
 - Smartphone and tablet
- TouchDisplay on unit
 - Power and communication with motor unit via RS232
 - Possibility to program the motor unit with the TouchDisplay

Option

- Master air quality sensor [76050332]
 - Display of air quality and ventilation intensity
 - Integrated air quality sensor
 - Display of active program
 - Timer programming possible
 - Power via motor unit [connect directly to the motor unit]
- Slave air quality sensor [76050333]
 - Always in combination with Master
 - Wireless communication with Master
 - Power voltage 230V / 50Hz
 - Integrated air quality sensor
 - Same information as on the Master available
- 4-position switch [on request]
 - Limited functionality



TouchDisplay

MODELS

DESIGNATION	ARTICLE NUMBER
Endura Delta 380 T4	76050804
Endura Delta 380 T4 PH	76050805
Endura Delta 380 T2/B2	76050806
Endura Delta 380 T2/B2 PH	76050807

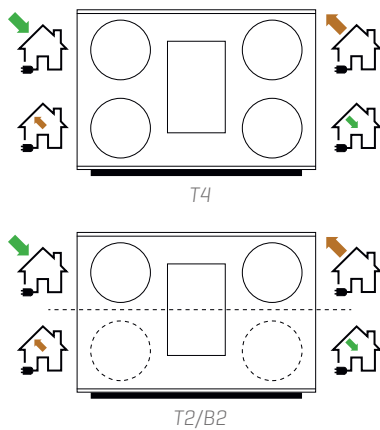
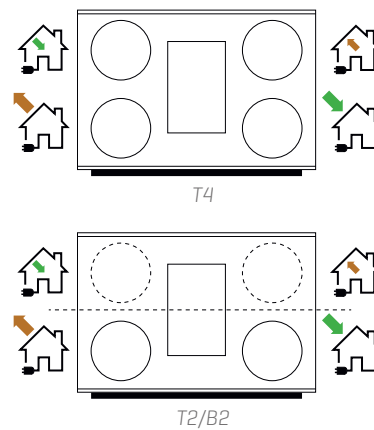
Endura Delta 380 Left [standard]

Endura Delta 380 Right [only possible after conversion]

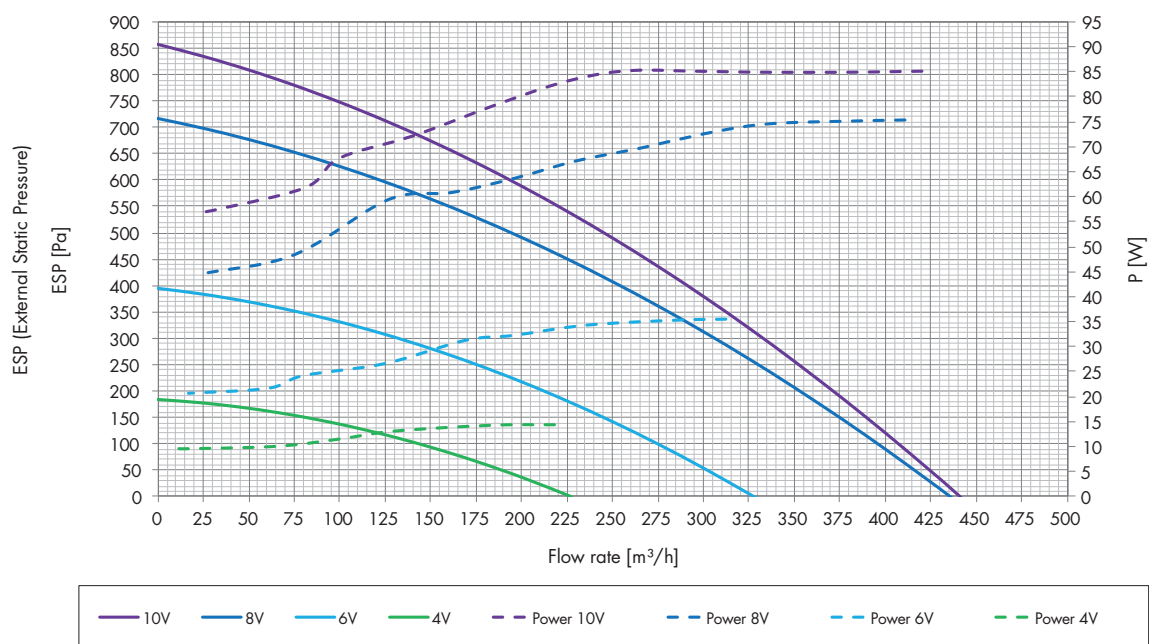
PRESSURE CURVES

 Fan curves for the Endura Delta 380
 pressure based on flow rate

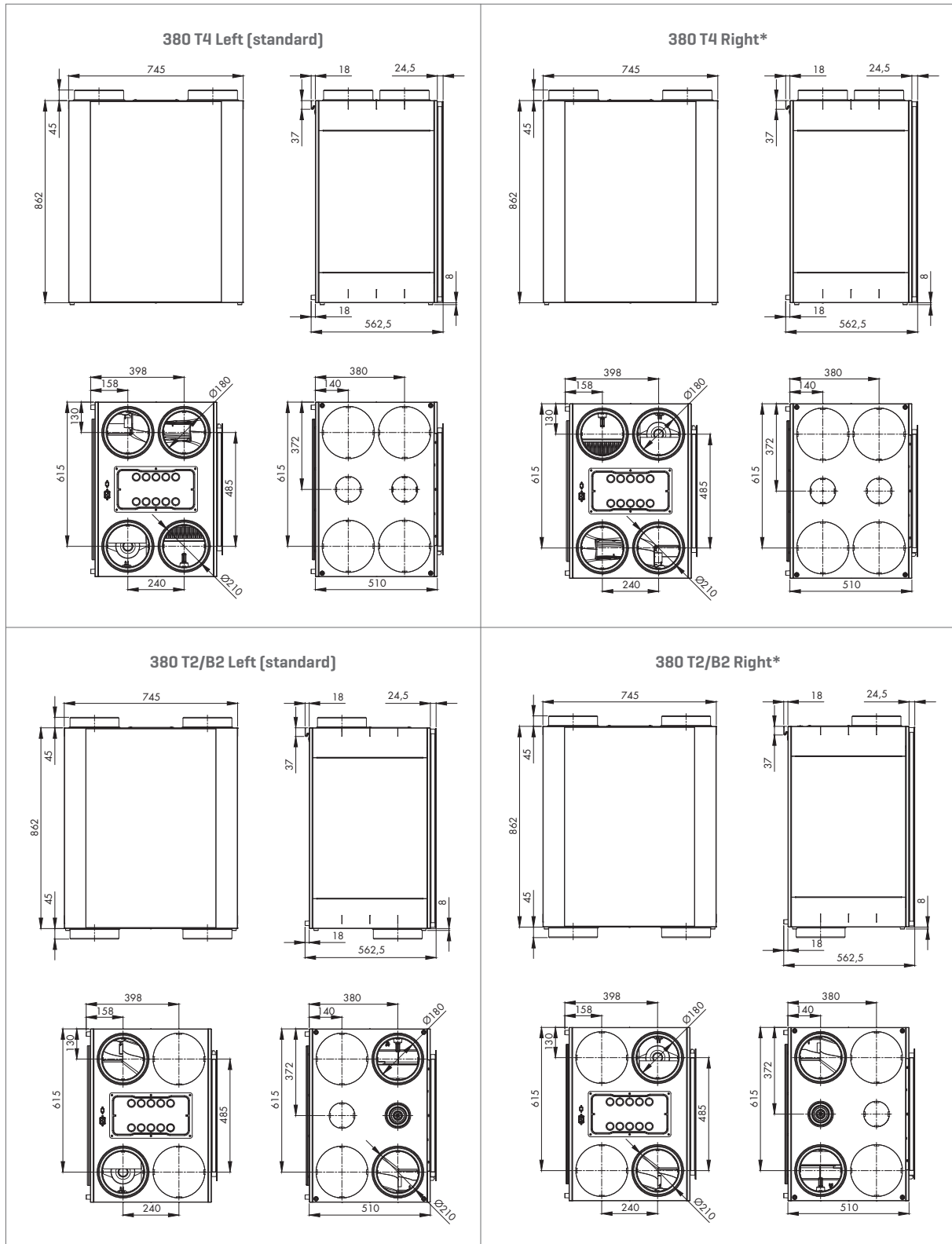
TECHNICAL DRAWINGS



* Only possible after conversion.

AREA OF APPLICATION

- Can be used in large houses [4-5 bedrooms] up to 450 m³/h at 150 Pa
- Mechanically supplied fresh air
- Mechanically drainage of used air
- Demand-driven ventilation thanks to integrated air quality sensors
- High-efficiency heat exchanger for reduced heat losses



Endura Delta 450 T4

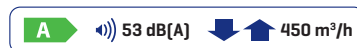

Endura Delta 450 T2/B2

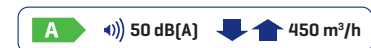

PRODUCT CHARACTERISTICS

EPB product data

- Max. capacity: 450 m³/h at 150 Pa
- Integrated plastic counter flow heat exchanger
- Maximum power consumption: 2 x 115 W

Ventilation system

- Ventilators
 - 2 EC motors
 - Supply voltage: 1 x 230V / 50Hz
 - Ventilators with backward-curved blades
 - Constant flow control: airflow remains constant
- Dimensions: H 862 x W 745 x D 520 mm
- Weight: 46 kg
- Available with 4 upper connections [T4] or 2 upper and 2 lower connections [T2/B2]
- Standard left-hand model, possible to convert to right-hand model
- Automatic full bypass
 - Modular control
 - Closing of the heat exchanger during warm weather
- 150/180 mm diameter connections in expanded polypropylene
 - Direct join to the unit:
 - EPP ducts: outer diameter 180 mm, inner diameter 150 mm
 - EPP ducts: with connecting sleeve: outer diameter 210 mm, inner diameter 180 mm
 - Other ducts: 180 mm diameter can be connected directly onto the ventilation system

- Integrated condensation drain Ø32 mm
- Extremely airtight appliance
- 2 x coarse [G4] cartridge filters [PM1 [F7] optional for supply]
 - Maintenance-friendly
 - Large filter surface area
- Integrated TouchDisplay in front panel
 - Touchscreen
 - Possibility to configure and control ventilation unit
 - Error feedback
 - Filter message
 - Visualization of current ventilation conditions
- Ethernet connection [RJ45 connector]
 - Possibility to control unit via tablet / smartphone via local network
- External input/output contacts
 - *Open input contact [digital 0-24 V]*
 - Supply and extract disabling option – e.g. emergency OFF to switch off supply flow rate
 - Supply switch-off
 - Drainage switch-off
 - Activation of fireplace function via external contact
 - *Open output contact [digital 0-24 V]*
 - Error message
 - Filter message
 - *0-10V analogue input*
 - *0-10V analogue output*

FUNCTIONS

- Operation
 - According to automatic mode [program]
 - Manual control
 - Timers
 - Via integrated air quality sensors [RH, CO₂ & VOC]
 - Via optional, external air quality sensors
- Demand-driven ventilation thanks to integrated air quality sensors
 - Relative humidity
 - VOC [volatile organic compounds]
 - CO₂
 - Ventilation levels adapted in accordance with measured air quality
- Automatic frost protection
 - Temporary imbalance and flow restriction to prevent freezing of the heat exchanger
- Extra frost protection option through installation of pre-heating element
 - Electrical pre-heating element
 - Modular power
 - Max. power: 1000 W
- Breeze function
 - Breeze function for optimum cooling in summer [summer bypass with adjustable ventilation level]
 - Automatic and manual bypass activation
 - 4-seasons automatically controlled indoor temperature
- Fireplace function
 - Activated via external pulse switch
 - Temporary imbalance on supply side [overpressure] to aid ignition process
- Holiday mode
 - Input of start and end dates during prolonged absence
 - System ventilates at maximum energy efficiency
- Filter message
 - Via smartphone
 - On integrated TouchDisplay
 - On external control unit [optional]
 - Timer-controlled

CONTROL

Standard

- With Endura Delta app
 - iOS, Android
 - Smartphone and tablet
- TouchDisplay on unit
 - Power and communication with motor unit via RS232
 - Possibility to program the motor unit with the TouchDisplay

Option

- Master air quality sensor [76050332]
 - Display of air quality and ventilation intensity
 - Integrated air quality sensor
 - Display of active program
 - Timer programming possible
 - Power via motor unit [connect directly to the motor unit]
- Slave air quality sensor [76050333]
 - Always in combination with Master
 - Wireless communication with Master
 - Power voltage 230V / 50Hz
 - Integrated air quality sensor
 - Same information as on the Master available
- 4-position switch [on request]
 - Limited functionality



TouchDisplay

MODELS

DESIGNATION	ARTICLE NUMBER
Endura Delta 450 T4	76050808
Endura Delta 450 T4 PH	76050809
Endura Delta 450 T2/B2	76050810
Endura Delta 450 T2/B2 PH	76050811

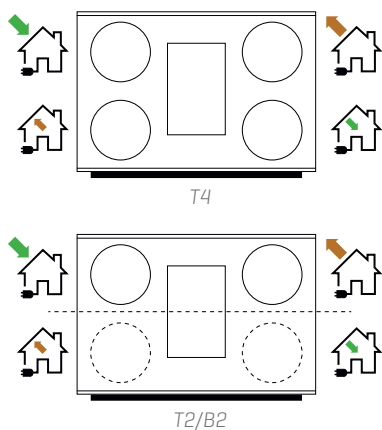
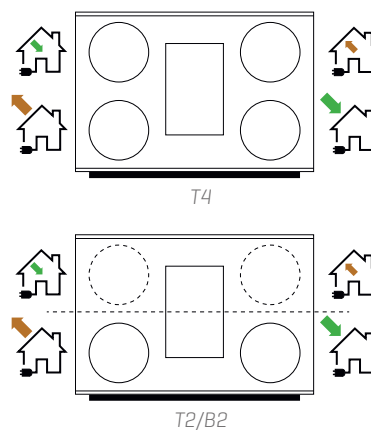
Endura Delta 450 Left [standard]

Endura Delta 450 Right [only possible after conversion]

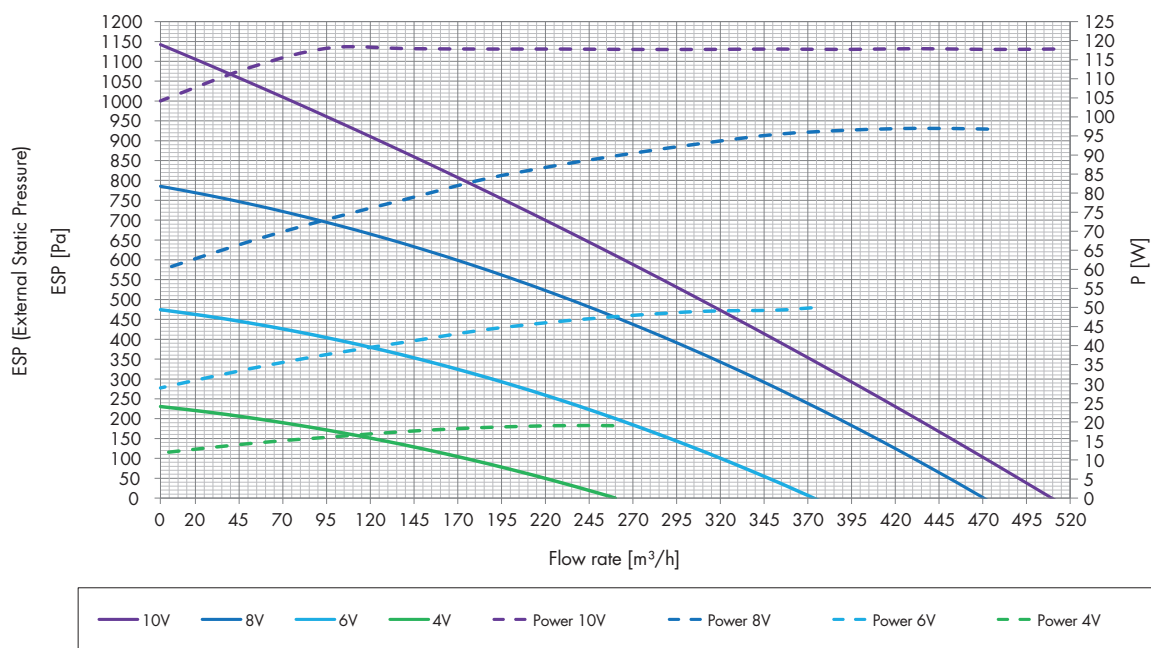
PRESSURE CURVES

 Fan curves for the Endura Delta 450
 pressure based on flow rate

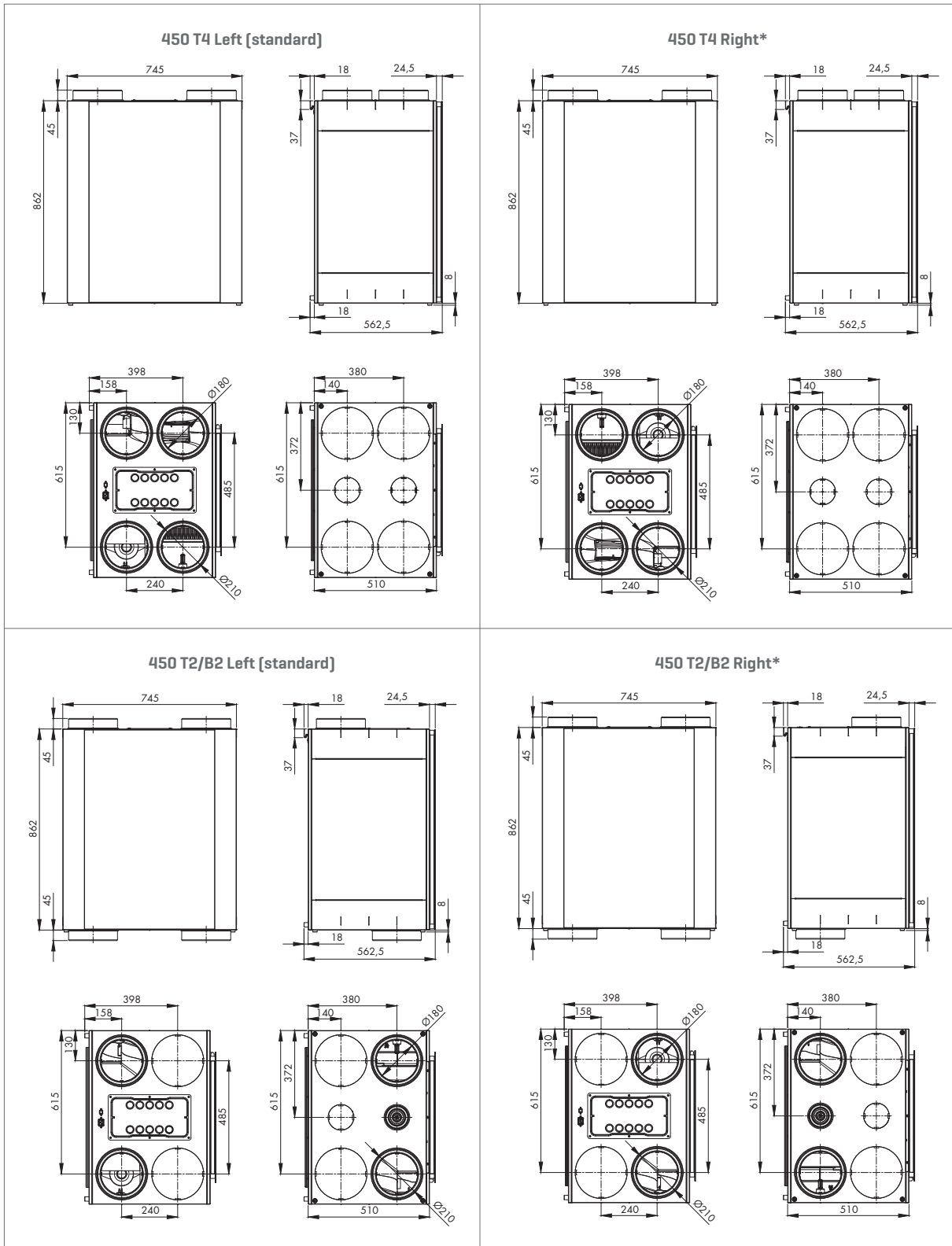
TECHNICAL DRAWINGS



* Only possible after conversion.

OVERVIEW ENDURA DELTA 330-380-450

Fan curves for the Endura Delta
 pressure based on flow rate

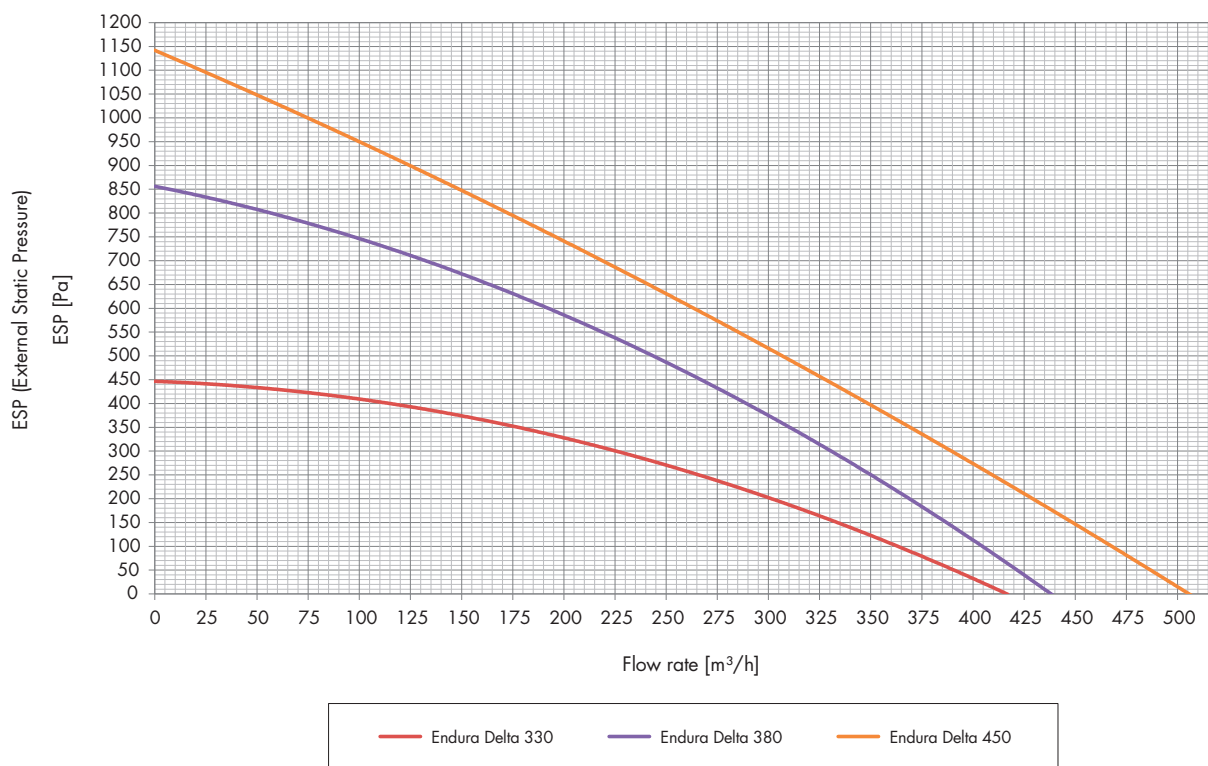

MODELS

Description	Item no.	Description	Item no.	Description	Item no.
ED 330 T4	76050800	ED 380 T4	76050804	ED 450 T4	76050808
ED 330 T4 PH	76050801	ED 380 T4 PH	76050805	ED 450 T4 PH	76050809
ED 330 T2/B2	76050802	ED 380 T2/B2	76050806	ED 450 T2/B2	76050810
ED 330 T2/B2 PH	76050803	ED 380 T2/B2 PH	76050807	ED 450 T2/B2 PH	76050811

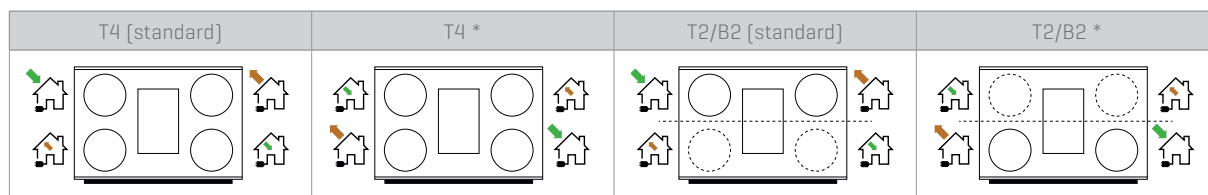

* Only possible after conversion.

TECHNICAL SPECIFICATIONS

	Endura Delta 330	Endura Delta 380	Endura Delta 450
Flow rate	330 m³/h at 150 Pa	380 m³/h at 150 Pa	450 m³/h at 150 Pa
Fans	EC fan with forward curved blades, constantly driven by volume	EC fan with backward curved blades, constantly driven by volume	EC fan with backward curved blades, constantly driven by volume
Max. power	2 x 85 W	2 x 83 W	2 x 115 W
Max. power preheater	1000 W	1000 W	1000 W
Heat exchanger	PS	PS	PS
Thermal yield measured according to EN308	89% at 100 m³/h 87% at 150 m³/h 84% at 250 m³/h 82% at 325 m³/h 81% at 350 m³/h	88% at 100 m³/h 85% at 200 m³/h 83% at 300 m³/h 81% at 400 m³/h	87% at 100 m³/h 83% at 250 m³/h 81% at 350 m³/h 79% at 470 m³/h
Connections	Ø 180 mm 4 upper connections [T4] 2 upper and 2 lower connections [T2/B2]	Ø 180 mm 4 upper connections [T4] 2 upper and 2 lower connections [T2/B2]	Ø 180 mm 4 upper connections [T4] 2 upper and 2 lower connections [T2/B2]
Bypass	Modulating	Modulating	Modulating
Filters	2 x coarse [G4] PM1 [F7] optional	2 x coarse [G4] PM1 [F7] optional	2 x coarse [G4] PM1 [F7] optional
Controls	Smartphone / Tablet Optional: 4-position switch	Integrated TouchDisplay Smartphone / Tablet Optional: 4-position switch	Integrated TouchDisplay Smartphone / Tablet Optional: 4-position switch
Frost protection	Automatic through temporary imbalance Optional preheater [proportional and no imbalance]	Automatic through temporary imbalance Optional preheater [proportional and no imbalance]	Automatic through temporary imbalance Optional preheater [proportional and no imbalance]
Casing	Coated steel plate	Coated steel plate	Coated steel plate
Weight	41 kg	46 kg	46 kg
Materials inner part	Expanded Polypropylene	Expanded Polypropylene	Expanded Polypropylene
Condensate discharge	Integrated Ø 32 mm	Integrated Ø 32 mm	Integrated Ø 32 mm
Contacts	0-10 V IN/OUTPUTS	0-10 V IN/OUTPUTS	0-10 V IN/OUTPUTS
Sensors	Integrated temperature sensors Integrated humidity sensor Integrated VOC sensor Integrated CO ₂ sensor	Integrated temperature sensors Integrated humidity sensor Integrated VOC sensor Integrated CO ₂ sensor	Integrated temperature sensors Integrated humidity sensor Integrated VOC sensor Integrated CO ₂ sensor

Endura Delta 330 T4
 49 dB(A)  330 m³/h

Endura Delta 380 T4
 52 dB(A)  380 m³/h

Endura Delta 450 T4
 53 dB(A)  450 m³/h

Endura Delta 330 T2/B2
 47 dB(A)  330 m³/h

Endura Delta 380 T2/B2
 49 dB(A)  380 m³/h

Endura Delta 450 T2/B2
 50 dB(A)  450 m³/h